

Operating Manual

Process photometer

AQUACON SiO₂-01

(PC- Cabinet)

Feb. 2011

Fillerkampsweg 1 – 5 • 31832 Springe OT Eldagsen • Tel.: 05044/887-0 (Fax: -99)

E-Mail: info@iotronic.de





Internet: <http://www.iotronic.de>



iotronic
ELEKTROGERÄTEBAU GMBH

1	GENERAL GUIDELINES FOR SAFETY	3
2	PRINCIPLE OF OPERATION	4
3	DESCRIPTION OF THE PROCESS PHOTOMETER	4
3.1	Analytical Part	7
3.2	Measurement and Control	7
3.3	Operation and Measurement Security	7
3.4	Automatic Operation	8
3.5	Manual Operation	9
3.6	Display/Set Parameters	10
3.6.1	Limit Value	11
3.6.2	Alarm value	11
3.6.3	Analog Output setting (mode, start value and end value)	11
3.6.4	Sampling Interval	12
3.6.5	Titer/Calibration Factor	12
3.6.6	Rinsing Time	12
3.6.7	Reagent Volume	12
3.6.8	Blank Value (E)	12
4	SWITCHING FUNCTIONS OF AQUACON SIO2-01	13
4.1	External Switching	13
4.2	Display in the standby mode:	13
4.3	Analysis state relay	13
4.4	Limit Value Relay	14
4.5	Alarm Limit Relay	14
4.6	Current Output	14
5	START-UP AND MAINTENANCE INSTRUCTIONS	15

5.1	Connection of sample water	15
5.2	Connection of reagent, bleeding of pumps and tubes	15
5.3	Replenishment of Reagent	15
5.4	Changing of Tube box	16
5.5	Recalibration of the Process analyzer	16
5.6	Maintenance interval	16
5.7	Shut down procedure	16
6	ALARM MESSAGES	17
7	TECHNICAL DATA	17
8	SPECIFICATIONS	18
9	CONNECTION DIAGRAM	18
9.1	Set 0/4 - 20 mA-Output	18
9.2	Connections	19
9.3	Installation	20
10	APPENDIX	21
10.1	Analysis cycle AQUACON SiO2-01	21
10.2	Spare part and consumable item list	22
11	TROUBLESHOOTING GUIDE	23

1 General Guidelines for Safety

	WARNING	(Non-observance or misapplication of the contents of the „Warning“ section could lead to serious accident, including death or injury)
Turn off the power supply.		
Working without disconnecting the power supply may cause an electrical shock. Before engaging upon any working procedures make sure to disconnect the power supply.		
		
Electrical Shock		
No remodelling !		
Never remodel an analyzer. Otherwise, a serious accident may result. IOTRONIC will not be responsible for any accident or damage of any kind which is caused by the user remodelling the analyzer.		
		
No Remodeling		
Operating site must be free of water and humidity		
The analytical instrument is not designed to be water-proof or dust-proof. The use of the analyzer in places where water splashes or humidity is high may result in an electrical shock or short-circuit.		
		
Prohibited		

	CAUTION !	(Non-observance or misapplication of the contents of the „Caution“ section could lead to serious physical injury to the user or serious damage to the product.)
Specified power only		
Do not operate the analyzer on voltage which is not specified on the label on the right side of the transmitter housing. Failure to do so can result in damage or fire. Only the specified power level is to be applied.		
		
Caution		
Do not damage or change power cable !		
Do not scratch, damage, process, or pull the power cable forcibly. Non-observance could cause a fire or an electrical shock.		
		
Caution		

Notes on operation

- Dropping the device or subjecting it to strong impacts may result in faulty performance. Handle the analyzer with care.
- Select an installation site convenient for future maintenance and inspection, and fix the device carefully so that it is free of vibrations.

2 Principle of Operation

The process photometer AQUACON SiO₂-01 performs a photometric analysis of the silica concentration, at regular intervals, of the water under examination. The entire operation, which includes filling and rinsing of the measuring cuvette, is controlled by a microprocessor.

The proprietary reagent formulations developed by the manufacturer are added to the measuring chamber by means of a tube pump and mixed with the sample in the measuring chamber. The colour formed as a result of the formation of the β -molybdosilicic-acid complex is detected by the monochromatic photometric detection system built into the measuring chamber. The measurement results are displayed on a touchscreen as ppb SiO₂.

3 Description of the Process Photometer

The process photometer is delivered completely mounted in a polycarbonate wall cabinet, ready for installation. This includes all the components for sample and drain connection, measurement chamber, reagent pumps, display and connections for remote display and control. All functions of the process photometer can be operated via touchscreen.

View of the process photometer AQUACON SiO2-01

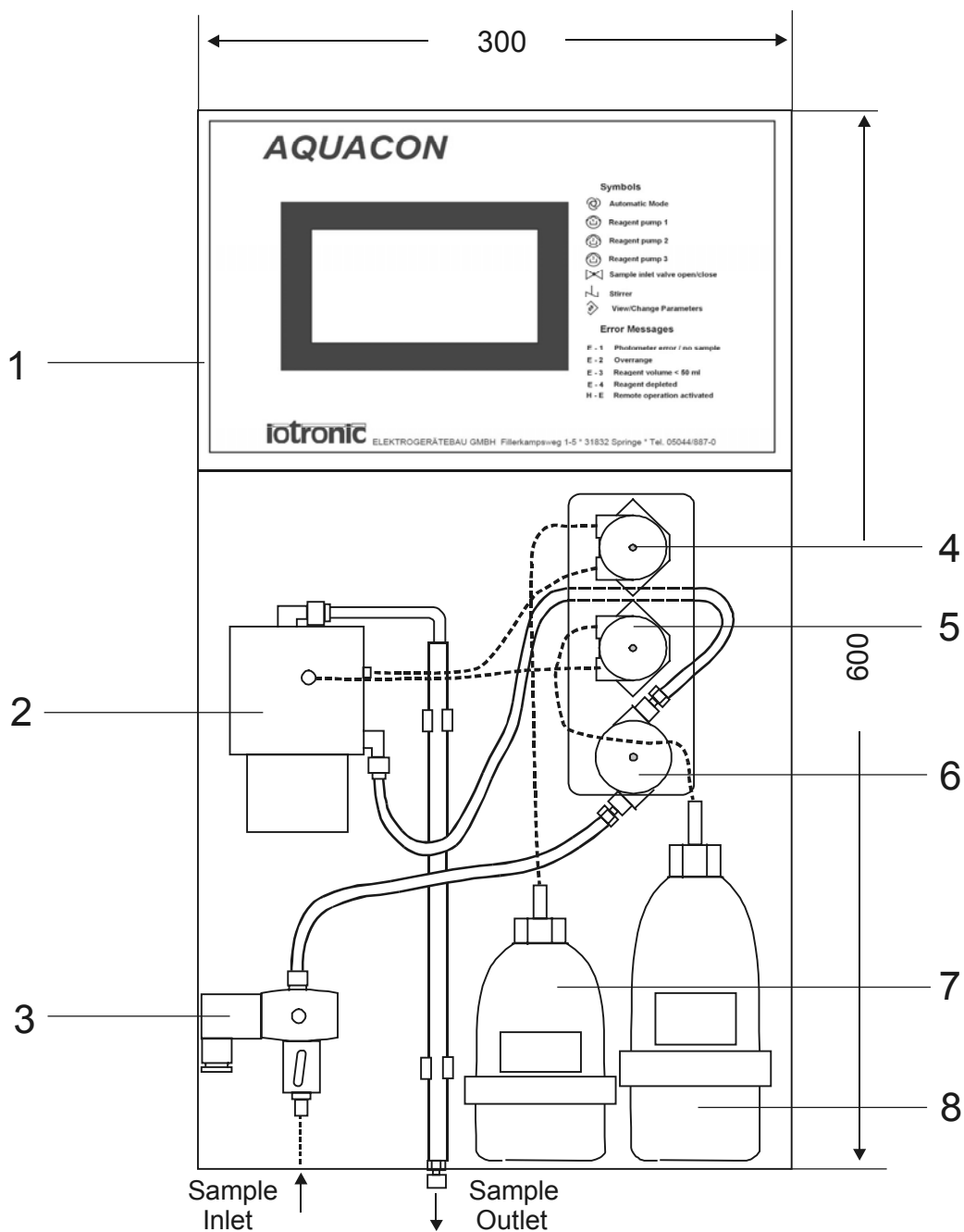







- 1 Transmitter with touchscreen
- 2 Measuring chamber
- 3 Sample inlet valve
- 4, 5 Tube pumps
- 6 Flow meter
- 7 Reagent 1 vessel (SI-R1001, 250 ml)
- 8 Reagent 2 vessel (SI-R1003, 500 ml)

AQUACON SiO2-01 Touchscreen

AQUACON



Symbols

-  Automatic Mode
-  Reagent pump 1
-  Reagent pump 2
-  Reagent pump 3
-  Sample inlet valve open/close
-  Stirrer
-  View/Change Parameters







Error Messages

- E - 1 Photometer error / no sample
- E - 2 Overrange
- E - 3 Reagent volume < 50 ml
- E - 4 Reagent depleted
- H - E Remote operation activated



ELEKTROGERÄTEBAU GMBH Fillerkampsweg 1-5 * 31832 Springe * Tel. 05044/887-0

Explanation of Symbols

Symbol	Function
	Select Automatic Mode, start an analysis
	Reagent pump 1 on/off
	Reagent pump 2 on/off
	Reagent pump 3 on/off (optional)
	Sample inlet valve open/close
	Stirrer on/off
	View / Change parameters

3.1 Analytical Part

The transmitter of the process photometer AQUACON SiO2-01 is contained in a compact housing and includes the microprocessor which recognizes the absorbance (extinction), displays the final calculated result on a touch screen and controls the operation of the process photometer with respect to sampling, rinsing of the measurement chamber, dosing of the reagent and surveillance of the photodetection system.

3.2 Measurement and Control

The user may set a freely-programmable maximum limit of the measured value, which, when exceeded, will activate a relay contact which is found on the connection terminal rail (see chapter 3.6.1). In addition, an analog 0/4-20 mA current output delivers a signal proportional to the measured values (see chapter 9.1). The start and end of output range are freely programmable (see chapter 3.6.3).

All user-defined settings are maintained during power failure to the instrument.

3.3 Operation and Measurement Security

When the end-user defined maximum alarm value is exceeded or when an error occurs (ERROR E-1 to ERROR E-4) the alarm relay will activate.

The actual reagent volume of reagent 1 is calculated by the microprocessor and is corrected for usage after each analysis. Once the calculated remaining reagent volume falls below the factory-predetermined value of 50 ml, an alarm message (ERROR E-3) is displayed on the touchscreen and the alarm relay (found on the transmitter terminal connector) is activated. The remaining 50 ml reagent is sufficient for approximately 40 analyses (calculated for reagent Si-R1003). Should this alarm be ignored and the reagent is depleted, a second alarm message (ERROR E-4) is displayed on the touchscreen, subsequent relay activation is initiated by the process photometer AQUACON SiO2-01 and the analyzer stops.

The optical transparency of the measurement cuvette is measured at the start of each analysis. An automatic zero adjustment takes place before each measurement to compensate colored or turbid samples or discoloration/contamination of the cuvette windows. Once the factory-predetermined limit to the zero adjustment is exceeded, another alarm message (ERROR E-1) is displayed on the touchscreen, the alarm relay is activated and the analysis cycle is interrupted.

Before and after each analysis, the measuring chamber is flushed with sample water to remove the water sample from the last analysis (which maybe is coloured when silica was detected) and replace it with the actual water sample which shall be analyzed. To assure that enough water is flushed, the flushing process is supervised by a flow meter. If the flow rate of the sample water is too low, this is detected by the flow meter and an alarm message (ERROR E-1) is displayed on the touchscreen, the alarm relay is activated and the analysis cycle is interrupted (sample failure).

When the sample interval defined by the end-user has elapsed, the process photometer will automatically resume measurement as normal and repeat the procedure until sample flow is re-established.

The analysis cycle may be interrupted at any stage by touching the button “Hand” or the button “Param” on the touchscreen.

The process photometer remains in manual operation mode until the automatic mode is selected by pressing the appropriate symbol or touch button.

3.4 Automatic Operation

The process photometer will automatically carry out an analysis once the “Start” button is pressed.

On the return of power to the instrument following a power failure, the process photometer will automatically enter the automatic mode and starts a measurement. This is displayed as state “MEASURING”.

On the touchscreen, the last actual measured value of analysis is displayed. If the result of analysis is below the lower measuring limit of the analyzer, the display shows ”00,0 ppb”.

Below the last measured value, the sets parameter for “Limit value” and for “Alarm value” are displayed. This values can be parametrized by the end-user (see chapter 3.6).

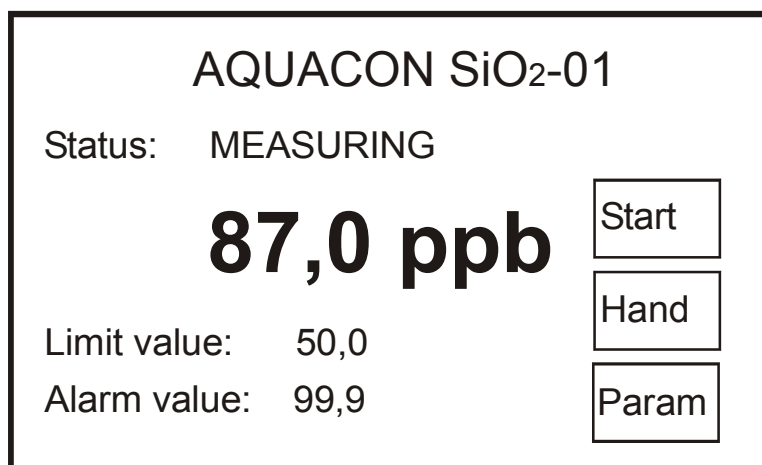

The automatic analysis cycle can be interrupted at any stage by touching the button “Hand” or the button “Param” on the touchscreen (see 3.5).

When the upper measurement range is exceeded, the alarm message „ERROR E-2“ is displayed as state on the touchscreen and the alarm relay is activated.

3.5 Manual Operation

Manual operation of the process photometer is useful for maintenance, commissioning of the analyzer and when correction of alarm conditions during normal operation occur.

Manual operation of the process photometer is effected by pressing the button “Hand” on the touchscreen. During the internal zero adjustment of the photometer short delays can occur. Automatic operation is interrupted and the screen displays the manual mode (state: MANUAL). Simultaneously, the actual absorbance (extinction) value is displayed in the upper display.

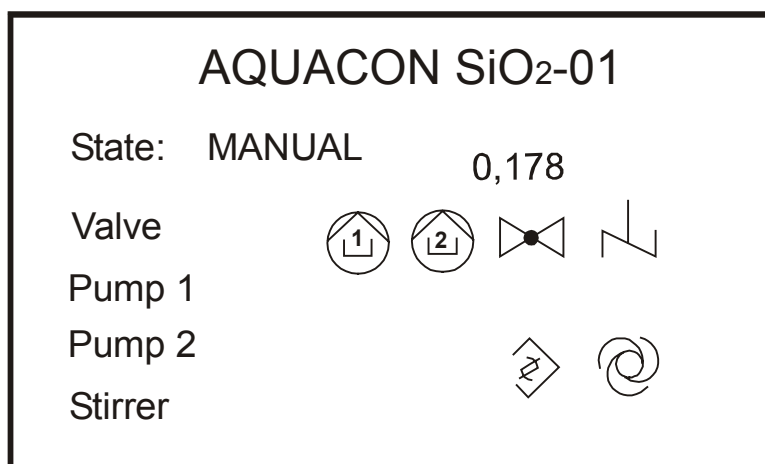

During manual operation, the pumps, the sample inlet valve and the stirrer can be activated/deactivated by touching the appropriate symbols. The active part will be displayed with inverse letters.

During manual operation, the mode can be switched to automatic mode and an analysis can be started by touching the symbol .

During manual operation, the mode can be switched to parameter mode by touching the symbol .

3.6 Display/Set Parameters

The parameter mode can be activated from automatic mode by touching the button “Param” or from manual mode by touching the symbol 

AQUACON SiO ₂ -01		
Limit value:	50,0	Start
Alarm value:	99,9	
Output mode:	4-20 mA	Hand
Output start:	00,0	>>
Output end:	99,9	

In parameter mode, a new screen will be displayed which shows the parameters Limit value, Alarm value, Output mode, Output start and Output end. By touching the button “ >> ”, a second screen will be displayed with the parameters Sampling interval, Calibration factor, Rinse time and Reagent volume.

AQUACON SiO ₂ -01		
Sampling interval:	10	Start
Calib. factor:	1.00	
Blank value:	00,0	Hand
Rinse time:	15	<<
Reagent volume:	246	

By touching the button “ << ”, the first parameter screen will be displayed again.

All parameters are set to a certain value (factory settings), but can also be parametrized by the end-user (see the following chapters 3.6.1 – 3.6.7).

To change the parameters, the corresponding values must be touched. Then, a parameter specific screen opens where the new parameter values can be typed by touching of the figures (except parameter “Output mode”).

AQUACON SiO₂-01

Alarm value: 99,9

1	2	3
4	5	6
7	8	9
	0	

Save

Clear

To leave the screen and confirm/save the new parameter value, the button “Save” must be touched. To leave the screen without saving, the button “Clear” must be touched.

3.6.1 Limit Value

The limit relay will activate when the end-user defined maximum limit value is exceeded. The factory-predetermined limit is set to 50,0 ppb. A value between 0 and 99,9 ppb may be chosen.

3.6.2 Alarm value

The alarm value is factory-predetermined to the upper measurement range 99,9 ppb. The alarm relay will activate when the end-user defined maximum alarm value is exceeded and an error message is shown on the touchscreen. A value between 0 and 99,9 ppb may be chosen.

3.6.3 Analog Output setting (mode, start value and end value)

An analog current signal (0/4 - 20 mA), proportional to the measured value, may be directed from the process photometer AQUACON SiO₂-01 to remote recording/controlling devices. The mode, the start value and the end value of the analog output can be parametrized by the end-user.

The mode of the analog output can be switched from 0-20 mA to 4-20 mA by touching of the corresponding value on the touchscreen. No further confirmation is required. The start and end values can be set to values between 0 and 99,9 ppb. The set end value must be higher than the set start value.

3.6.4 Sampling Interval

The sampling interval between two automatically initiated samples may be programmed. The factory-predetermined sample interval is set to 10 min. A values between 1 and 99 min. may be chosen.

3.6.5 Titer/Calibration Factor

The process photometer AQUACON SiO2-01 may be re-calibrated by entering a titer/calibration factor (see chapter 5.5). A value between 0.00 and 9.99 may be chosen.

3.6.6 Rinsing Time

The measuring chamber is rinsed for 15 seconds before an analysis takes place. The preset rinsing time may be altered by the end-user. A value between 15 and 99 seconds may be chosen.

Depending on the length of the sample inlet tube and the water flow rate, the rinsing time should be long enough to flush the sample lines and fill the measuring cuvette with fresh sample. A tube length of max. 5 m is recommended between sample valve and the analyzer.

3.6.7 Reagent Volume

The remaining reagent volume of the 500 ml reagent container is calculated and stored in memory by the microprocessor. A value between 0 and 999 ml may be chosen.

The automatic operation mode starts again when the button “Start” is touched.

3.6.8 Blank Value (E)

The entered blank value for a silica contentration will be subtracted from the analysis result. The value may be changed in small steps by briefly pressing the roll keys. This parameter is set to “0” and should normally not be changed.

The automatic operation mode starts when the key  is pressed.

4 Switching Functions of AQUACON SiO₂-01

CAUTION:

Before opening the cover below the process photometer display, the AQUACON SiO₂-01 must be disconnected from the mains supply.

4.1 External Switching

The process photometer AQUACON SiO₂-01 has a potential-free input contact which may be used to control the instrument from a remote position/device. When the input contact is closed the process photometer will automatically carry out an analysis, when the input contact is open the process photometer completes the actual analysis and stops.

The process analyzer is delivered with bridged external switching contact into female. For using external switching contact remove this bridge! During the interval between two analyses the process photometer may be activated by a short off/on impulse of the external contact.

4.2 Display in the standby mode:

In the standby mode the display will show “STANDBY” and the last measured value. If the external contact is open, „H-E“ will additionally be displayed on the touchscreen.

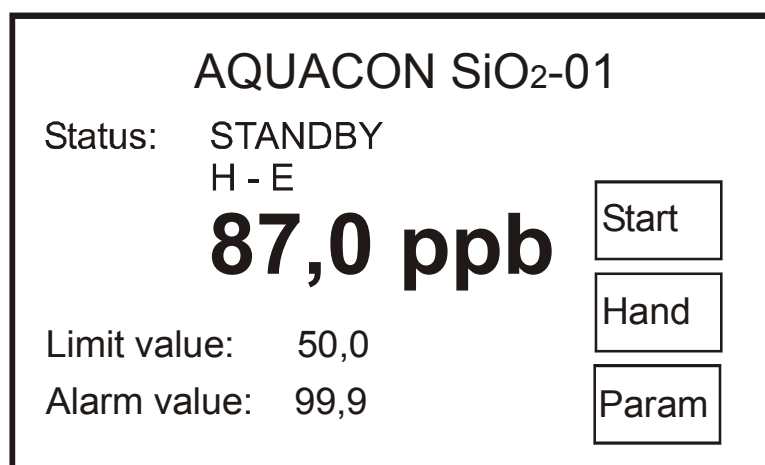

When an error message occurs this will be displayed additional to „H-E“.

4.3 Analysis state relay

The analysis state relay K 1 is activated during the time when the analyzer operates an analysis.

4.4 Limit Value Relay

The potential-free limit value K 2 relay is activated when the end-user defined limit is exceeded. During the automatic operation mode, “limit value” will be displayed when the measurement results are higher than the set limit value.

4.5 Alarm Limit Relay

The potential-free alarm relay is activated when an alarm is exceeded within the process photometer. The alarm is caused by an error in the optical system, when the measurement range is exceeded, when the flow rate is too low or when the reagent volume falls below than 50 ml. The appr. alarm message will be displayed as “ERROR E-1, ERROR E-2, ERROR E-3” or “ERROR E-4” (see chapter 3.3).

4.6 Current Output

The process photometer AQUACON SiO2-01 delivers a current output, 0 or 4 to 20 mA, which is proportional to the measurement range selected by the end-user (see chapter 9.1). This current output may be used as input to remote recording devices, for data processing, controlling functions etc. The current output is independent of resistance load up to a value of 500 ohm. The start and end value of the current output signal can be set by the user within the measurement range.



Don't connect any external voltage to the connections of the current output. Failure to observe this information could result in damage to the equipment.

See above, " 3.6.3 Setting the Analog Output". To avoid resolution losses of the current output signal the user defined measuring range should be $> 6\%$ of the total measurement range. The start value should be lower than the end value. Setting the start value higher than end value results in a constant output of 20 mA. Similarly, setting the end value lower than that of the start value results in a constant 0 or 4 mA output.

5 Start-up and Maintenance Instructions

CAUTION:

As soon as the analyzer is connected to the main supply, automatic operation commences. This is required for automatic restart of the analyzer in the event of a power failure. At start-up, it is necessary to access the Manual Operating mode by touching the "Hand" button as soon as the analyzer is connected to main supply and is operational.





5.1 Connection of sample water

1. Connect inlet and outlet connectors (6/4; 8/6) max. length 5 m
2. Connect power supply to device
Caution: see label on the housing for specified voltage
3. Select the sample inlet valve to „open“ (press button  on the touchscreen)
4. Carefully open the manually-operated valve beneath the solenoid operated valve to set the sample flow (20-30 l/h)

Caution: Maximum sample pressure 10 bar!

IF THE SAMPLE FLOW IS TOO LOW, AN ERROR E-1 WILL BE DISPLAYED.

5.2 Connection of reagent, bleeding of pumps and tubes

1. Open the reagent vessel top. Ensure that the pump tube is installed and the pump head is screwed down.
2. Switch on the stirrer (button ) and the first pump (button ) in order to fill the suction-lances and pressure-tubes (Sign: the extinction in the display is rising).
3. After filling the tubes switch off the pump and stirrer.
4. If there is a second or third reagent available, repeat step 1-3 with this reagents.
5. Rinse the measuring chamber by activating the sample inlet valve (button ) and stirrer (button ) in order to wash out the reagent entered while filling the tubes
6. Select automatic operation (button ). The device now operates in automatic mode and start the measurement.

Perform 2 to 3 analyses. Regard correct filling by observing the measurement outlet tube with the selected sample flow conditions. When satisfied that the system is performing correctly, the parameter settings may be carried out prior to automatic operation

5.3 Replenishment of Reagent

The reagent bottle may be replaced, after setting the analyzer to manual mode. Now the volume of reagent must be entered in „Param“ mode step to 250 (if the volume of reagent 1 is 250 ml) or to 500 (if the volume of reagent 1 is 500 ml). See also chapter 3.6.7.

Important: The handling with chemical standards and reagents can be dangerous. Before the reagent bottles are connected or replaced, it is necessary to read their specific MSDS (material safety data sheets).

5.4 Changing of Tube box

Replacement of the complete tube-box by pressing the brackets at the sides, take off the old box and give up a new box.

Important:

All tube boxes must be replaced after consumption of 5 bottles reagent or latest after 6 months.

5.5 Recalibration of the Process analyzer

Under normal conditions, a re-calibration of the process analyzer is not required since the reagent to sample ratio have been correctly determined at the time of manufacture. However should the need arise to verify the process analyzer, a standard solution may be introduced. In the unlikely event of a deviation from the introduced standard (incorrect reagent strength, pump tube aging, incorrect pump tube, contaminated measuring cell), a titer/calibration factor may be calculated as follows:

$$\text{titer/calibration factor} = \text{Standard solution value} : \text{Measured value}$$

Should the titer/calibration factor deviate by more than 20 % from 1, then a change of the tube box or a cleaning of the measurement chamber is maybe necessary.

5.6 Maintenance interval

A maintenance of the analyzer should be made after 5 consumed reagent bottles or latest after 6 month. A maintenance should include at least an optical control of the analyser, a function control and a change of the tube boxes. If necessary, the maintenance should also include a cleaning of the measurement chamber and of the injectors for the tube connection at the measurement chamber.

5.7 Shut down procedure

If the analyzer is shut down for an extended period of time, all reagents and samples should be removed out of tubings and the measurement chamber, and all tubings and the measurement chamber should be cleaned and flushed with deionized water.

Important:

It absolutly must be avoided that sample water with reagents flows through or remains in the sample valve or flow meter !!!

This can cause serious damages and can influence the function of the analyzer.

6 Alarm Messages

Message in display	Description	ACTION
ERROR E -1	Error in the optical system; the analyzer operation is interrupted: - contaminated cuvette windows - defective light source - defective photodetector - no sample - flow rate too low	Check sample inlet valve, clean the meas. chamber, check flow rate, call maintenance service.
ERROR E -2	Measurement range exceeded	Verify if silicic acid concentration is too high or if the measurement chamber is contaminated. Check stirrer function.
ERROR E -3	Reagent volume has dropped below the factory preset value of 50 ml. The operation of the analyzer remains unaffected until reagent is depleted.	Replace reagent soon.
ERROR E -4	Reagent depleted. The analyzer results are no longer valid.	Replace reagent.
H -E	Remote operation activated	

7 Technical Data

Current output	0/4 - 20 mA, max. load 500 ohm
Display	240 x 128 dots, Touchscreen
Relays	1 x Alarm, potential-free 230 V/50 Hz, 3A 1 x Limit, potential-free 230 V/50 Hz, 3A 1 x Analysis state, potential-free 230 V/50 Hz, 3A
External Switching	potential-free contact, 18 V DC, ca. 4 mA
Power Supply	110 - 230 V -- 50/ 60 Hz
Power Consumption	approx. 16 VA
Dimensions	640 x 315 x 190 mm (H x W x D)
Protection	IP 65 (transmitter housing)
Connections	Plugs with circular connection 1,5 mm ²
Temperature	5° to 45°C, at consumption of reagents within 6 months

Since it is company policy to continuously improve its product range, we reserve the right to make changes in the product design without notification to its users

8 Specifications

Parameter	Silica/Silicic Acid SiO ₂
Description	Microprocessor-controlled analyzer for the determination of dissolved Silica / Silicic Acid in water. AQUACON SiO2-01
Typical Applications	Monitoring and control of de-ionisation water plant. Monitoring and control of steam-water circuit of steam-generating plant
Method of working	Photometric determination of the dissolved Silica following the formation of the reduced β-molybdosilicic acid complex
Measuring Range	1,0 – 99,9 ppb SiO ₂
Resolution	0,1 ppb
Accuracy	2 % of end value
Reproducibility	0,5 ppb
Zero-point Stability	automatic adjustment
Number of Samples	1
Sample	
Operating Pressure	0,1 - 10 bar
Temperature	18 - 30 °C
Sample Volume	25 ml per analysis (excluding cuvette rinsing)
Sample Condition	clear, with particles < 0.5 g/l ; < 50 μm
Chemical Demands	pH 4 - 8, PO ₄ ³⁻ , NH ₃ < Si
Drain	pressure free into open drain
Reagents	
Number	2
Storage Temperature	10 – 30°C
Usage/analysis (appr.)	0.3/1.2 ml
Reagent volume	250/500 ml
Suitable for analysis (approx.)	400
Analysis	
Cycle (approx.)	13 min., including rinsing,
Sample interval	1 min - 99 min

9 Connection Diagram

9.1 Set 0/4 - 20 mA-Output

The 0/4 – 20 mA output can be set by changing the appropriate parameters (see chapter 3.6.3).

9.2 Connections

In – and outputs are available at circular connectors at the top of the device.



CAUTION: technical data !

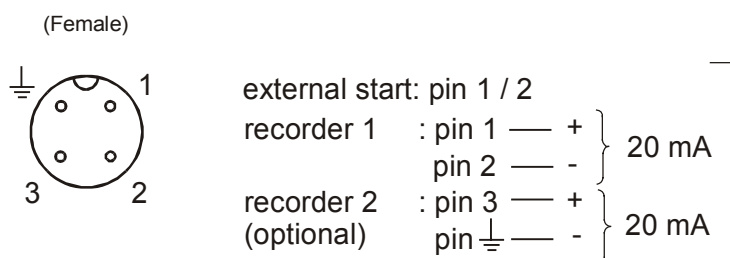
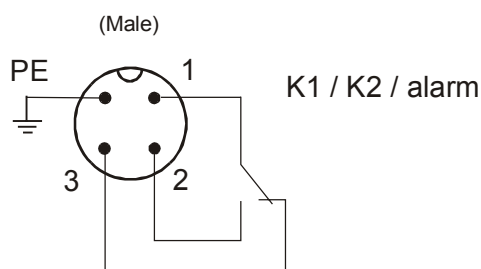
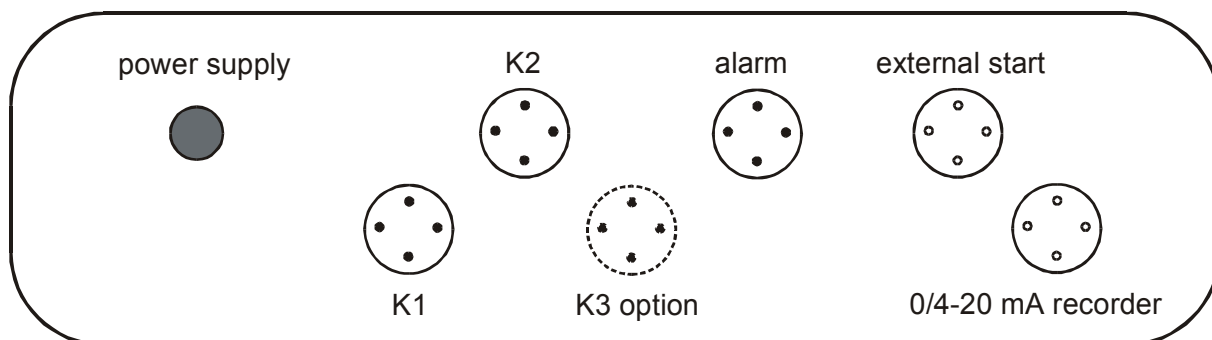

caution !

do not connect any voltage to these terminals

Power supply	Power supply (110 - 230 V, 50/60 Hz)	PE	protection earth
K1	Analysis status signal	K2	Limit value relay 1
external start	potential-free input contact	alarm	alarm limit relay
20 mA recorder 1	0/4 – 20 mA output (max. load 500 Ω)	K3	Limit value relay 2
20 mA recorder 2 (optional)	0/4 – 20 mA output (max. load 500 Ω)		(optional)

9.3 Installation



WARNING

Only Qualified Personnel !

Only Specified Power Supply !

See required power supply as noted on instrument.

Observe local regulations!







Install a power supply that can be disconnected (plug, switch).

Take care for use of the protective covers for not used connectors.

Do not install measuring-or control cables in parallel or close distance in the same cable guide with power supply.

10 Appendix

10.1 Analysis cycle AQUACON SiO2-01

Length	Operation			 1	 2
15 -99 s	Rinsing of the measurement chamber		X		
10 s	Sample degasification	X			
~ 40 s	Automatic zero adjustment				
2 s	Injection of reagent 1	X		X	
5 s	Mixed	X			
3 min.	Waiting period				
5 s	Injection of reagent 2	X			X
5 s	Mixed	X			
9 min.	Waiting period				
11 s	Measurement				
20 s	Rinsing of the measurement chamber	X	X		
1 - 99 min.	Break time				

10.2 Spare part and consumable item list

Consumable item		Term		Catalog No
Reagent 1 for AQUACON SiO2-01	SI-R1001	250 ml		101 2735 01
Reagent 3 for AQUACON SiO2-01	SI-R1003	500 ml		103 2735 01
Tube-box	SK10	1 piece		121 0037 01
Spare parts			Catalog No	
Transmission pressure tubing	PT10	1 m		121 0014 01
Tube pump	SP10-2	1 piece		121 0008 02
Magnetic valve type 1 2/2 way (brass)	MV01-G	1 piece		121 0004 02
Magnetic stirring bar for measuring chamber				121 0044 01
Glass measuring cuvette (50 mm)				121 0045 02

Basic equipment of consumables are included in price

11 Troubleshooting Guide

Problem	Reason
On pressing the „automatic operation“ key switch, the analyzer does not enter automatic analysis cycle.	<ul style="list-style-type: none"> • The contact bridge for external switch function (see 4.1) is not installed or has no contact switch. „H-E“ appears in the display. Solution: install bridge • The measurement chamber is empty (i.e. no sample) or the sample is strongly coloured or contaminated.. The flow rate is too low. „ERROR E-1“ appears in the display. The analyzer will automatically re-enter the measurement cycle following the sample interval and reset the alarm Solution: Clean the measurement cuvette with 10% hydrochloric acid, check sample flow, check optical components (open measurement chamber and set analyzer to manual operation. The displayed absorption should increase when the optical path is restricted by an opaque object). Check the flow rate (should be appr. 200 – 500 ml/min). • Reagent is depleted or incorrect reagent volume entered. „ERROR E-4“ appears in the display. Solution: Replace reagent if depleted and reset reagent volume to the correct volume via parameter input..
The analyzer continuously displays setpoint overrange	<ul style="list-style-type: none"> • The setpoint selected is below the measured value. „ERROR E-2“ appears in the display. Solution: Verify the measured value by alternative analysis Increase setpoint value
The values displayed are erratic even though the actual measured variable is constant	<ul style="list-style-type: none"> • Reagent container is not opened to atmosphere. Vacuum drawn on the reagent vessel. Solution: Open the reagent bottle cap to release vacuum. Do not retighten. • Magnetic stirrer immobilised Solution: Open the measurement cuvette. Stirrer is switched on by manual operation. Check that the magnetic follower is not jammed by loosening gently with a glass stirring rod. Increase the motor voltage by adjusting the appropriate potentiometer in the terminal box. If the problem is not rectified, call Service. • Reagent tubing is kinked or the feed tube in the reagent container is pushed against the bottom of the vessel. Solution: Straighten all tubes and tilt feed tube away from the bottom of the reagent container • Sample pressure is too low to effectively flush the measuring cuvette after analysis The cuvette does not overflow or overflows very slowly during flushing cycle. Solution: Increase the sample pressure to above 0.1 bar. Open sample inlet valve to allow 200 ml water flow per analysis cycle..
A calibration factor differing widely from 1.00 must be used to achieve correct results	<ul style="list-style-type: none"> • Reagent is contaminated, reagent has expired, pump tube has exceeded. Solution: replace reagent; replace pump tubing.
Pumps or solenoid operated valves do not operate in manual mode	<ul style="list-style-type: none"> • A limited number of electromechanical drives may be simultaneously selected to prevent electrical overload. Solution: Switch off other electromechanical drives and try again.